

WHY NOT

Why Not

Family

Sofa / Bench / System

Designer

Luca Botto / 2010

Link

www.read-mo.re/why_not



PRODUCT SHEET

WHY NOT

Dati tecnici · Technical data · Données techniques · Technische Angaben

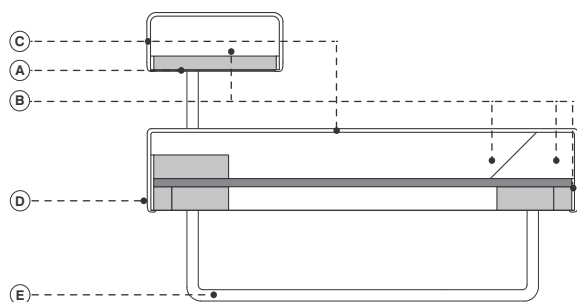

■ Legno massiccio di faggio	■ Solid beech	■ Bois de hêtre massif	■ Massivholz aus Buche
■ Multistrato di faggio	■ Multilayered beech	■ Multiplis de hêtre	■ Buchenschichtholz
A. Pannello di masonite	A. Masonite panels	A. Panneau de particules	A. Holzfaserplatte
B. Poliuretano espanso ignifugo indeformabile a quote differenziate	B. Flame-retardant undeformable polyurethane foam of different densities	B. Mousse polyuréthane expansé ignifuge indéformable à épaisseurs différenciées	B. Feuerfester formbeständige Polyurethanschaum in unterschiedlicher Dichte
C. Fibra di poliestere	C. Polyester fibers	C. Fibre de polyester	C. Polyester
D. Rivestimento fisso in tessuto o pelle	D. Fixed upholstery in fabric or leather	D. Revêtement pas déhoussable en tissu ou cuir	D. Unabziehbarer Bezug aus Stoff oder Leder
E. Acciaio	E. Steel	E. Acier	E. Stahl

Note · Notes · Annotation · Anmerkung

<ul style="list-style-type: none"> • Base personalizzabile con tinta cliente • Prodotto disponibile su misura con preventivo su richiesta • Su richiesta attacco per connessione elettrica e USB con sovrapprezzo • Cuscini extra disponibili • COM: tessuto cliente (tinta unita e h.140 cm.) - campione richiesto • COL: pelle cliente - campione richiesto • CAT. SPECIAL: prezzo e disponibilità su richiesta 	<ul style="list-style-type: none"> • Base customizable with customer's colors on request • This item can be tailor made with price on request • Electrical connection and USB upon request with upcharge • Extra cushions available • COM: client's fabric (plain colour and width 140 cm.) - sample required • COL: client's leather - sample required • CAT. SPECIAL: price and availability on request 	<ul style="list-style-type: none"> • Piètement disponible en autres finitions sur demande • Collection personnalisable sur demande • Sur demande connection électrique et USB avec surcoût • Autres coussins disponibles • COM: tissu fourni (couleur unie et hauteur 140 cm.) - échantillon nécessaire • COL: cuir fourni - échantillon nécessaire • CAT. SPECIAL: prix et disponibilité sur demande 	<ul style="list-style-type: none"> • Gestell in Kundenfarben auf Anfrage verfügbar • Produkt nach Maß verfügbar auf Anfrage • Elektrische Verbindung und USB-Anschluss auf Anfrage gegen Aufpreis • Weitere Kissen verfügbar • COM: Kundenstoff (einfarbig und Breite 140 cm.) - Stoffmuster nötig • COL: Kundenleder - Ledermuster nötig • CAT. SPECIAL: Preis und Verfügbarkeit auf Anfrage
----------------------------------------------------------------------------------------------------------------------------------------------------------------------------------------------------------------------------------------------------------------------------------------------------------------------------------------------------------------------------------------------------------------------------------------------------------------------------------------	--------------------------------------------------------------------------------------------------------------------------------------------------------------------------------------------------------------------------------------------------------------------------------------------------------------------------------------------------------------------------------------------------------------------------------------------------------------------------------	----------------------------------------------------------------------------------------------------------------------------------------------------------------------------------------------------------------------------------------------------------------------------------------------------------------------------------------------------------------------------------------------------------------------------------------------------------------------------	--------------------------------------------------------------------------------------------------------------------------------------------------------------------------------------------------------------------------------------------------------------------------------------------------------------------------------------------------------------------------------------------------------------------------------------------------------------------

Finiture base · Base finishes · Finitions piètement · Gestell Ausführungen



Cromato lucido
Polished chrome steel
Acier chromé brillant
Stahl Chrom poliert



Nero (RAL 9005)
Black (RAL 9005)
Noir (RAL 9005)
Schwarz (RAL 9005)

Sistema di aggancio · System connector · Systeme d'assemblage · Verbindungshaken Opzione · Option · Option · Opzjon



Sistema di aggancio tra elementi
Components connector
Systeme d'assemblage de socle
Verbindungssystem zwischen Elemente



Su richiesta attacco per connessione elettrica e USB con sovrapprezzo
Electrical connection and USB upon request with upcharge
Sur demande connection électrique et USB avec surcoût
Elektrische Verbindung und USB-Anschluss auf Anfrage gegen Aufpreis

Rivestimenti consigliati · Recommended coverings · Revêtements conseillées · Empfohlene Bezüge

• cat. A XTREME	• cat. C TREND	• cat. extra MOLLY	• cat. lux LUX 1
• cat. A STEP	• cat. C SUPERB	• cat. extra RIME	• cat. lux LUX 2
• cat. A ANGEL	• cat. C UMAMI	• cat. extra STEELCUT TRIO 3	• cat. imperial IMPERIAL 1
• cat. A MEDLEY	• cat. C HESTAN	• cat. extra COLLINE	• cat. imperial IMPERIAL 2
• cat. A MOOD	• cat. C DEANS	• cat. extra OPERA	• cat. imperial NABUK
• cat. A CRAZY	• cat. super REMIX 2	• cat. extra DANTE	• cat. special DROP
• cat. B EXTREMA	• cat. super CAPTURE	• cat. extra ARCO	
• cat. B IKON	• cat. super MODA	• cat. extra HALLINGDAL 65	
• cat. B SILVERTEX	• cat. super REVIVE 1	• cat. maxi COMFORT	
• cat. B SAMAR	• cat. super BREEZE FUSION	• cat. maxi DIVINA 3	
• cat. B FAME			
• cat. B MAIN LINE FLAX			

WHY NOT

cod. 8451 / 3 seater

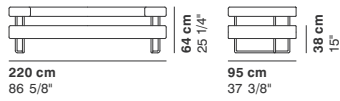

cod. 8452 / 4 seater

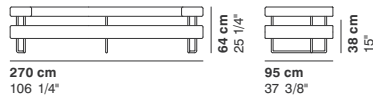

cod. 8469 / element 100

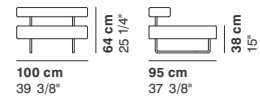

cod. 8470 / element 140

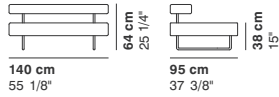

cod. 8453 / element 190

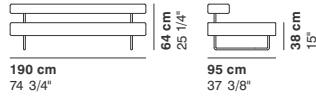

cod. 8454 dx / right half back element 190

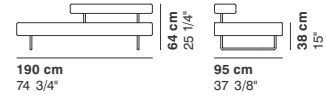

cod. 8455 sx / left half back element 190

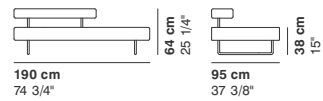

cod. 8456 sx / left element 190

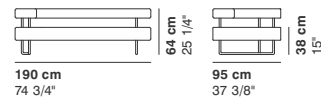

cod. 8457 dx / right element 190

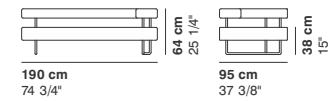

cod. 8458 / closed corner R 180

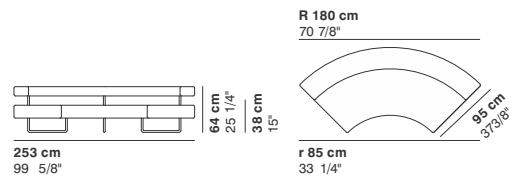

cod. 8459 / open corner R 180

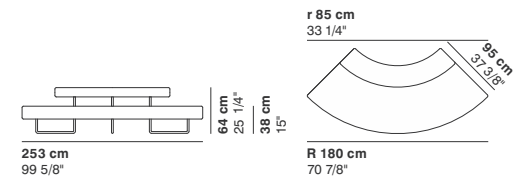

cod. 8460 / closed element R 395

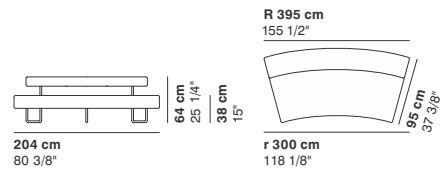

cod. 8461 / open element R 395

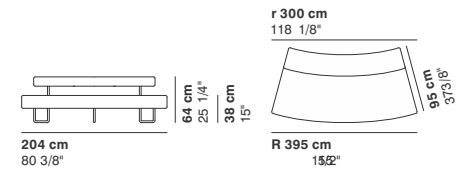

cod. 8464 dx / open element right half back R 395

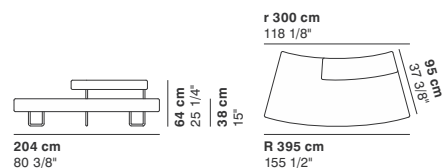

cod. 8465 sx / open element left half back R 395

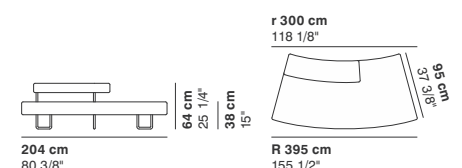

WHY NOT

cod. 8463 dx / closed element right half back R 395

cod. 8462 sx / closed element left half back R 395

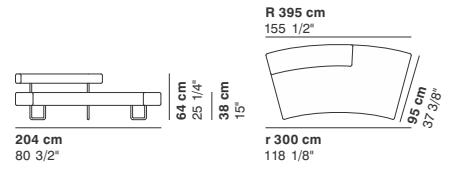
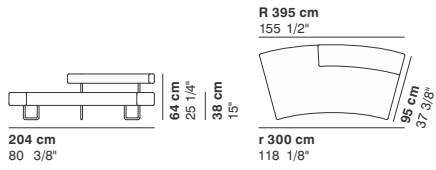

cod. 8466 / bench 190

cod. 8467 / bench R 180

cod. 8468 / bench R 395

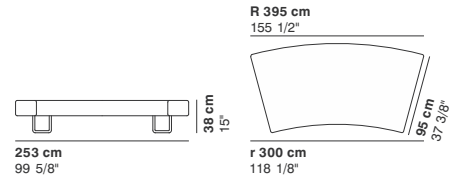
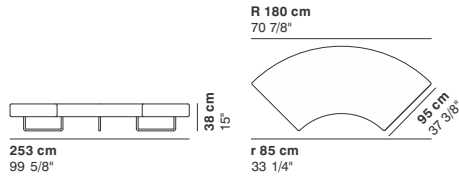
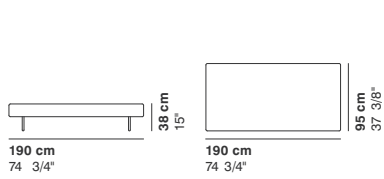

WHY NOT

cod. WHY01 / composition

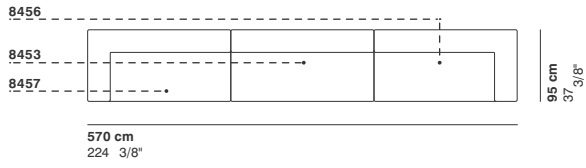

cod. WHY02 / composition

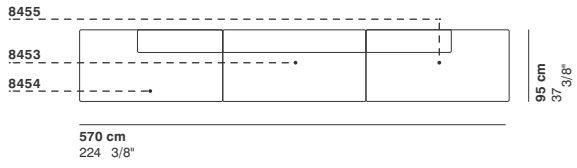

cod. WHY03 / composition

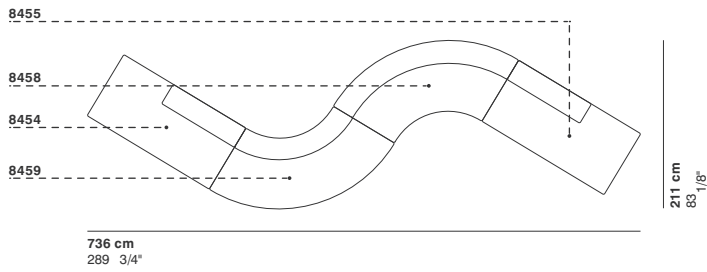

cod. WHY04 / composition

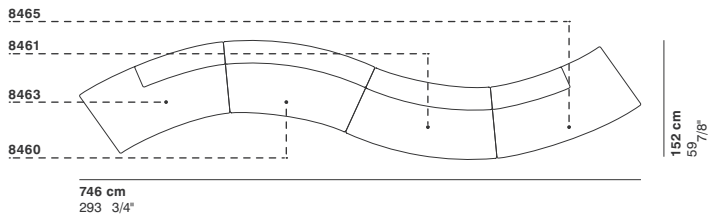

cod. WHY05 / composition

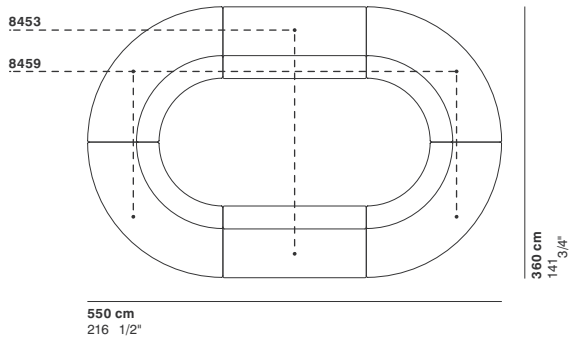

cod. WHY06 / composition

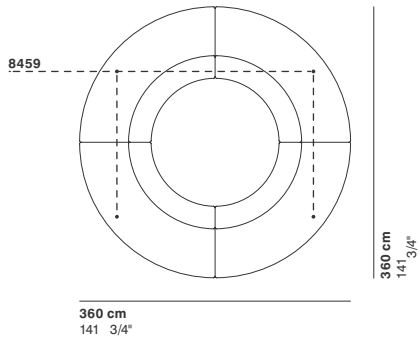

cod. WHY07 / composition

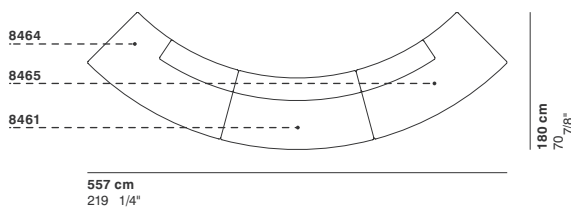

cod. WHY08 / composition

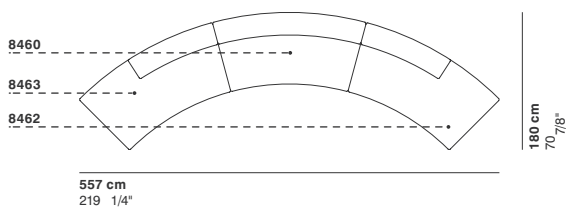



ISO 9001



ACCREDIA



FSC



CATAS



MADE IN ITALY